



INSTALLATION INSTRUCTIONS

Accessory
SPLASH GUARDS

Application
2015 ILX

Publications No.
BII 51696
Issue Date
MAY 2014

PARTS LIST

Left front splash guard



Right front splash guard

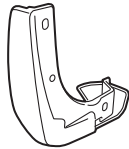

Left rear splash guard

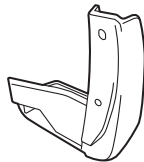

Right rear splash guard

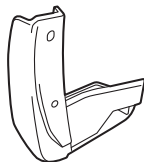

Left bracket



Right bracket

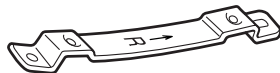

6 Self-tapping screws, 5 x 25 mm



4 Self-tapping screws, 5 x 16 mm



2 Clips

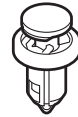

TOOLS AND SUPPLIES REQUIRED

- Phillips screwdriver
- Stubby Phillips screwdriver
- Pushpin
- High-quality paste wax

INSTALLATION

Client Information: The information in this installation instruction is intended for use only by skilled technicians who have the proper tools, equipment, and training to correctly and safely add equipment to your vehicle. These procedures should not be attempted by "do-it-yourselfers."

NOTE:

- Be careful not to damage the paint finish.
- These instructions show the left splash guards being installed. The same procedure applies to installing the right splash guards.
- Clean and wax the areas to be covered with a high-quality paste wax.

Installing the Front Splash Guards

1. Turn the steering wheel fully counterclockwise.

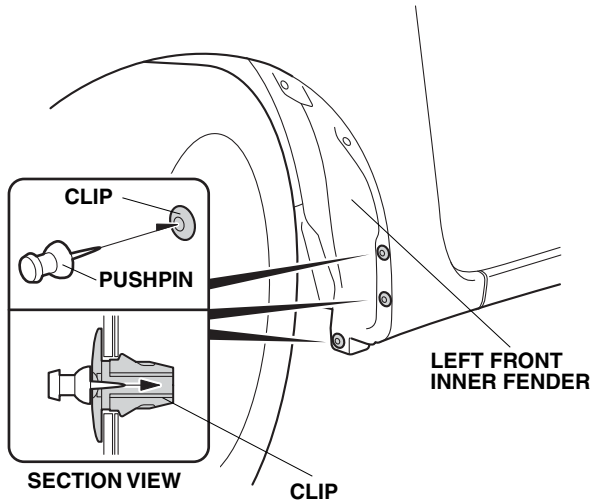

Q080301BJ

2. Locate three clips on the left front inner fender. Using a pushpin, pierce the center of each clip.
3. Install the left front splash guard onto the left front inner fender with three 5 x 25 mm self-tapping screws, and tighten them in the order shown.

NOTE: Make sure there is no gap between the left front splash guard and the vehicle body. If there is a gap, loosen the self-tapping screws, press and hold the splash guard against the body with the palm of your hand, and retighten the screws.

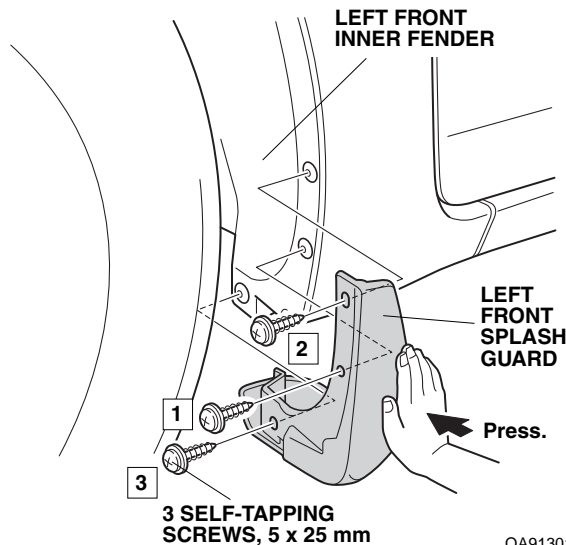

QA91301BJ

4. Turn the steering wheel fully clockwise, and repeat steps 2 and 3 to install the right front splash guard on the right side of the vehicle.

Installing the Rear Splash Guards

5. Locate and remove two self-tapping screws from the rear bumper.

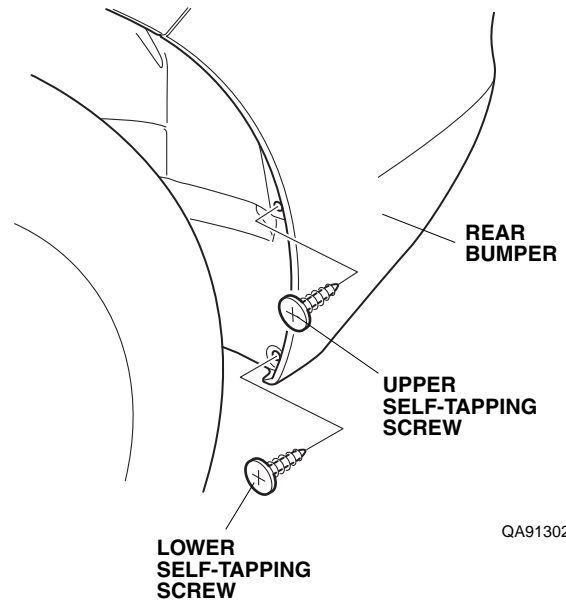

QA91302AJ

6. Insert the top edge of the left bracket behind the inner fender, and reinstall the upper self-tapping screw.

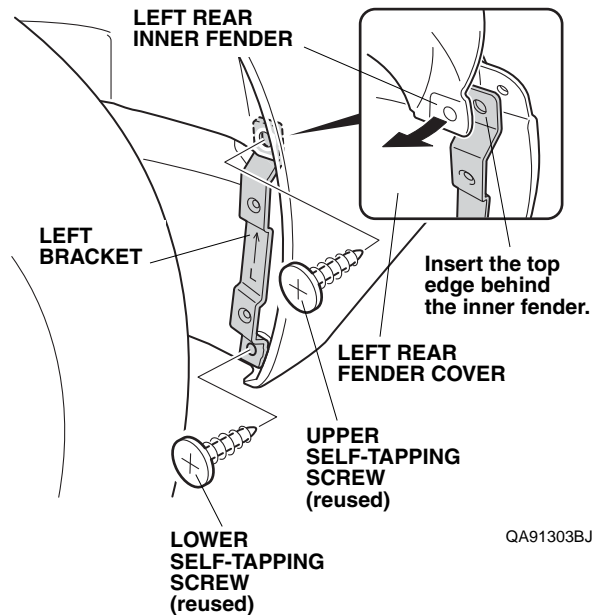

QA91303BJ

7. Reinstall the lower self-tapping screw.

8. Install the left rear splash guard onto the rear bumper with two 5 x 16 mm self-tapping screws, and tighten them in the order shown.

NOTE: Make sure there is no gap between the left rear splash guard and the bumper. If there is a gap, loosen the self-tapping screws, hold the splash guard against the bumper, and retighten the screws.

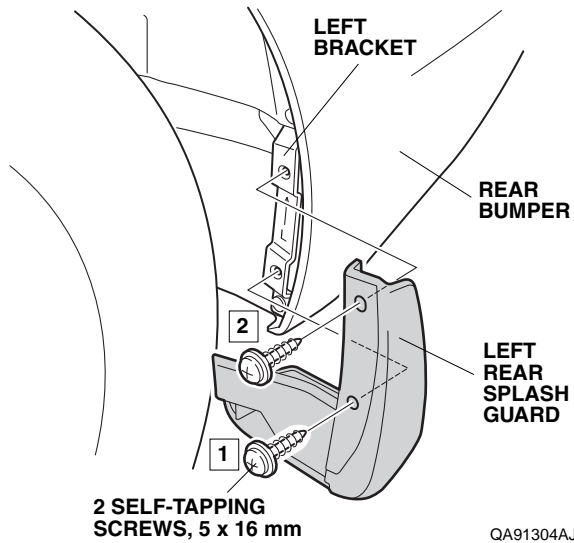

9. Secure the left rear splash guard to the rear inner under cover with one clip.

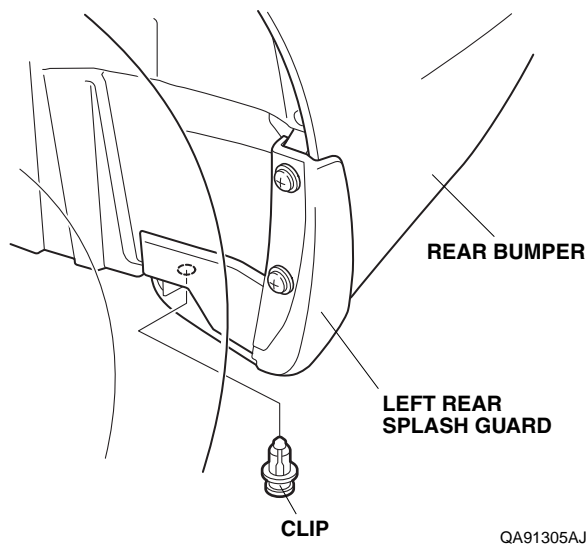

10. Repeat steps 5 through 9 to install the right rear splash guard on the right side of the vehicle.